

tecnoswitch 

Crono feel 

# CR035WB

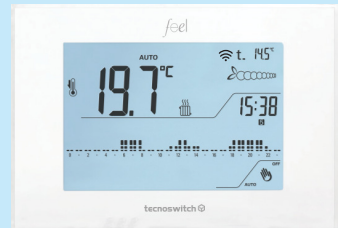

WI-FI WALL MOUNTED DAILY/WEEKLY TOUCH  
PROGRAMMABLE THERMOSTAT 230V

QUICK GUIDE

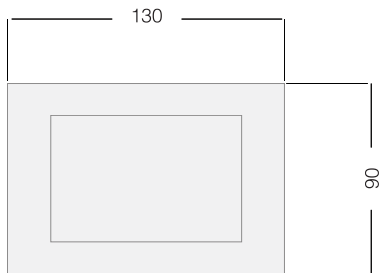
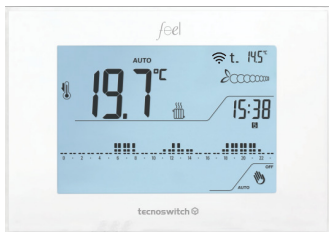

\*Unit of measure: mm

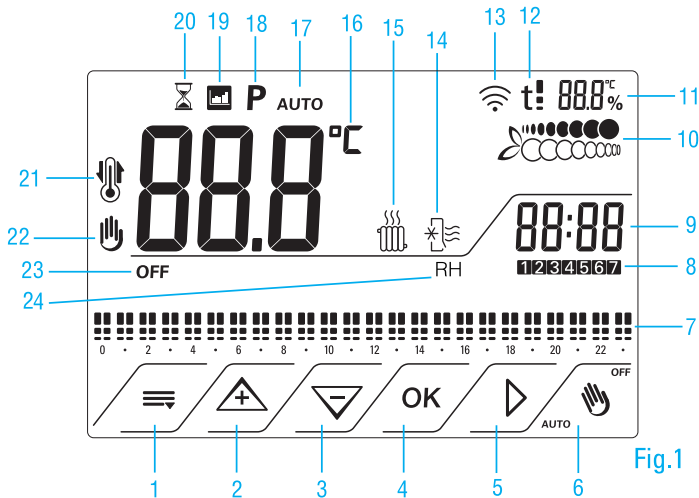







Fig.1

















## COMMANDS AND INDICATIONS

### KEYS LEGEND Fig.1

1.  Menu
2.  Increase
3.  Decrease
4.  Confirm
5.  Scrolls the next icon
6.  ON/OFF - Manual/Automatic

### DISPLAY LEGEND Fig.1

7.  Temperature levels T1, T2, T3
8.  Days of week
9.  Current time (Clock)
10.  Energy consumption savings indicator
11.  Set Temperature/Humidity
12.  Set temperature thresholds
13.  WiFi
14.  Cooling mode
15.  Heating mode
16.  Ambient Temperature
17.  Automatic Mode
18.  Set temperature levels
19.  Statistics
20.  COUNT-DOWN

21.  Frost protection

22.  Manual Mode

23.  Off

24.  Relative Humidity

**Note:** when the programmable thermostat is in Stand-by, press  to start the backlight. Now it can be set.

## INDEX OPERATION BY PROGRAMMABLE THERMOSTAT

Page

1. Installation	7
2. Factory Setting	9
3. On/Off	9
4. Set Day And Time	10
5. Daily programming of temperatures	10
6. Lock Setting	11
7. Reset	11

## INDEX APP

1. Configuration	12
2. On/Off	13
3. Automatic/Manual Mode	14
4. Weekly Programming	15
5. Delete Program	18
6. Language Setting	19
7. Multiple Associations	19

## 1.0 INSTALLATION

The device must be positioned about 1.5 meters above the floor, avoiding heat sources, windows and doors. It must be installed on the wall or on recessed boxes with 2 or 3 modules, in dry places.

To install the programmable thermostat it is necessary:

- Unhook the base from the thermostat. [Fig.1A – Fig.2A](#)
- Fix the base to the wall. [Fig.3A](#)
- Connect the external temperature probe.
- Hook the base to the wall. [Fig.4A](#)

### ASSEMBLY INSTRUCTION

Fig.1A



Fig.2A

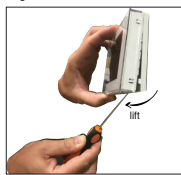

Fig.3A

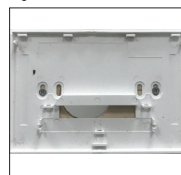
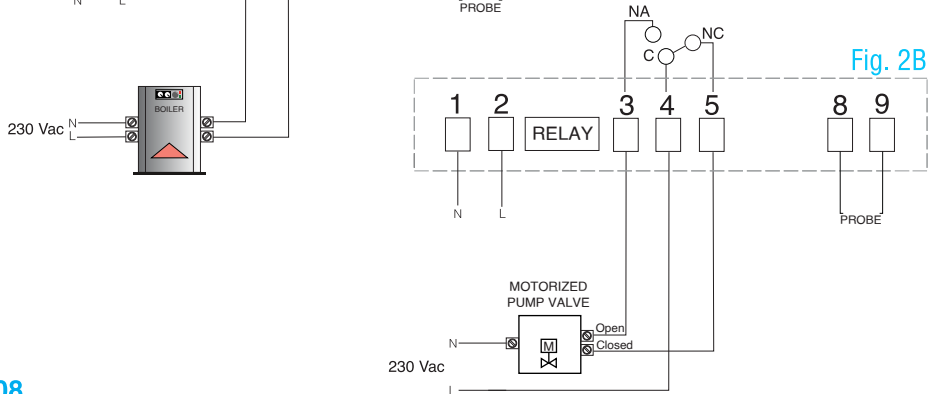
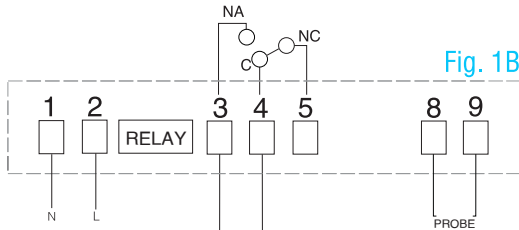

Fig.4A



# WIRING DIAGRAM

Connect the load to the terminals following the wiring diagram [Fig.1B](#) – [Fig.2B](#)



## 2.0 FACTORY SETTING

For faster use, the programmable thermostat is supplied with set programs:

- Heating program.

Temperature levels:

$$t_{\cdot}(T1) = 14^{\circ}\text{C} \quad t_{\cdot}(T2) = 18^{\circ}\text{C} \quad t_{\cdot}(T3) = 22^{\circ}\text{C}$$

- Cooling Program.

Temperature levels:





$$t_{\cdot}(T1) = 24^{\circ}\text{C} \quad t_{\cdot}(T2) = 26^{\circ}\text{C} \quad t_{\cdot}(T3) = 28^{\circ}\text{C}$$

- Frost protection function: + 5 ° C settable, active only in heating mode.
- Set temperature for MANUAL mode: +22°C.

## 3.0 ON / OFF







Press  for 3 seconds.

## 4.0 SET DAY AND TIME

Press the icons in sequence :  →  → the clock flashes → confirm with **OK** → use  or  to set hour/minutes → confirming with **OK**, the day value **1** (Monday) flashes → press  and select the desired day that it will flash → confirm with **OK**.

## 5.0 DAILY PROGRAMMING OF TEMPERATURES

It can customize the temperature levels at 30 minute intervals.





Press the icons in sequence :  →  →  up to position on **P** → pressing **OK**, the day value **1** flashes → confirm with **OK** → use  or  to set the desired temperature range at that time → press  to move on the next half hour and choose the desired temperature range and continue in the same way until you reach 11:30 pm → pressing **OK**, the days **1** and **2** flash alternately. Now you can:

- a) Copy the program from Monday **1** to Tuesday **2** pressing **OK** ;
- b) Set the Tuesday **2** program pressing  and confirm with **OK**.

Repeat the same steps to copy/set the other days, until **7** (Sunday).



## 6.0 LOCK SETTING

The device is provided with a 3 digit Lock Code.

Press the icons in sequence :  → (  +  ) for 3 seconds and **PAS** appears → use  or  to set the first digit → press  → use  or  to set to the other two digits → confirm with OK.

To deactivate it, repeat the same steps

## 7.0 RESET

Press the icons in sequence :  → (  +  ) for 3 seconds and **rSt** appears.

For more info see the manual on our website ([tecnoswitch.com](http://tecnoswitch.com)).

# QUICK GUIDE APP

## 1.0 CONFIGURATION

Download the free APP  “Crono feel” from the official stores  .

### Programmable Thermostat Configuration:

To turn on the wi-fi module, press the icons in sequence :  OFF  →  up to position on  → confirm with OK .  
 flashes → confirm with OK .

### Smartphone Configuration:

- Turn on GPS and Wi-Fi;
- Connect the smartphone to the programmable thermostat; (Fig.1)
- Start the App; (Fig.2)
- Enter the required data. (Fig.3 from 3A to 3E)

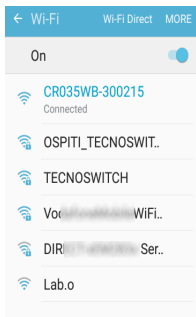

(Fig.1)



(Fig.2)

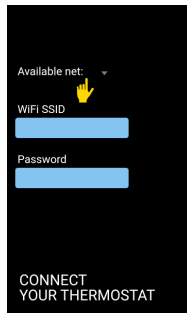

(Fig.3A)

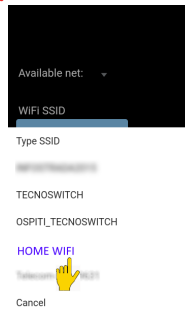

(Fig.3B)

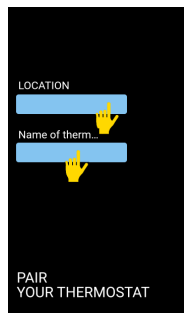

(Fig.3C)

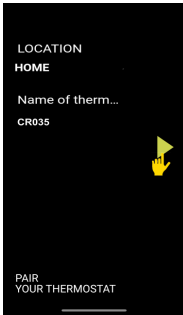

(Fig.3D)

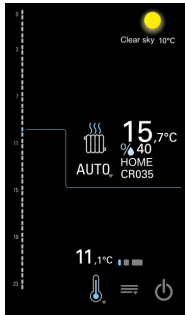

(Fig.3E)

After configuring the device, day and date will update automatically.  
You can watch the configuration on our TecnoSwitch IT  **YouTube** channel.

## 2.0 ON / OFF

Press  to switch ON / OFF the programmable thermostat. (Fig.4)

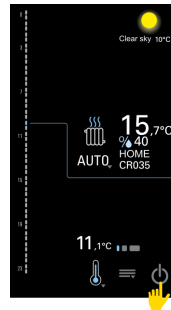

(Fig.4)

## 3.0 AUTOMATIC / MANUAL MODE

- Press **AUTO** to enable MANUAL MODE; (Fig.5)

To set the temperature:

- Press ; (Fig.6)
- Place your finger inside the circle  and scroll up  or down  to increase or decrease the temperature; (Fig.7 from 7A to 7C)

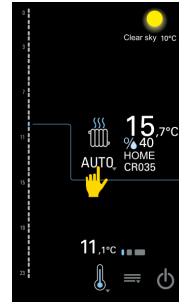

(Fig.5)

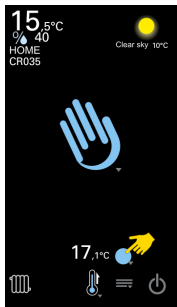

(Fig.6)

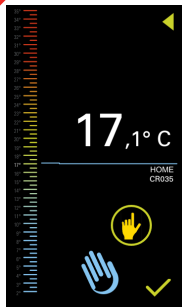

(Fig.7A)

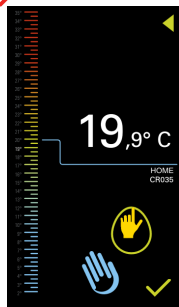

(Fig.7B)

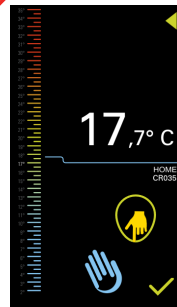

(Fig.7C)

Confirm with . (Fig.8);

Press  to enable AUTOMATIC MODE. (Fig.9A-9B)

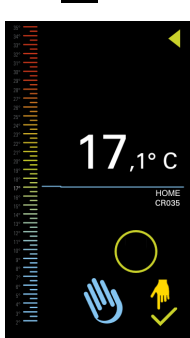

(Fig.8)

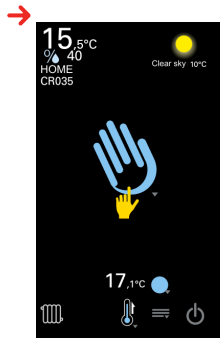

(Fig.9A)

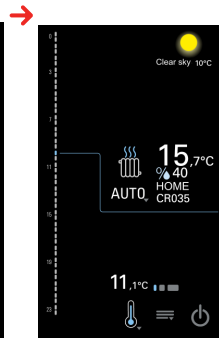

(Fig.9B)

You can watch the configuration on our TecnoSwitch IT  **YouTube** channel.

## 4.0 WEEKLY PROGRAMMING

Follow  to weekly programming; (Fig.10 from 10A to 10H)

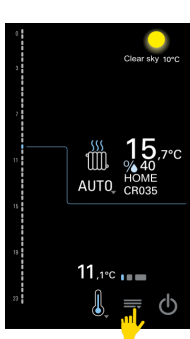

(Fig.10A)

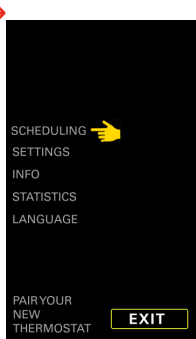

(Fig.10B)

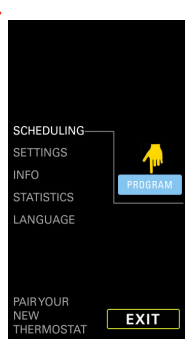

(Fig.10C)

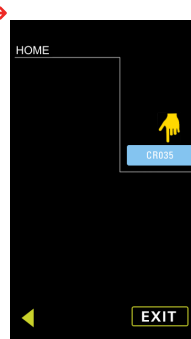

(Fig.10D)



(Fig.10E)



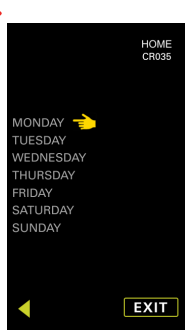

(Fig.10F)

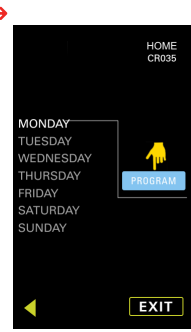

(Fig.10G)



(Fig.10H)

Place your finger inside the circle  and scroll up  or down  to set the desired time range



; (Fig.11 from 11A to 11C)

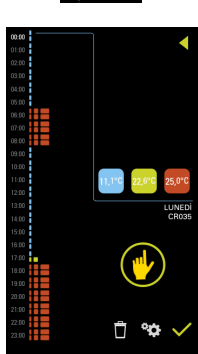



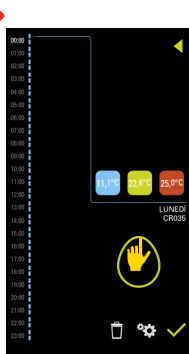

(Fig.11A)

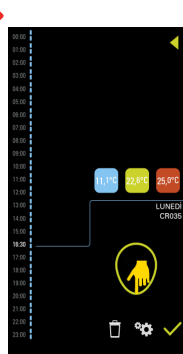



(Fig.11B)



(Fig.11C)

- Press  /  /  to set the desired temperature range at that time; (Fig.12)
- After programming, confirm with ; (Fig.13)
- Now you can:
  - a) Copy a program from one day of the week to another;
  - b) Set a different program for one or more days of the week.

a) To copy the programming, for example, Monday to Wednesday, press , , select **WEDNESDAY** and press  (Fig.13 – Fig.16);

b) To set, for example, the Wednesday program, press  (Fig.14), select **WEDNESDAY** (Fig.15) and press  (Fig.16). Follow the same procedure to copy / set the other days.

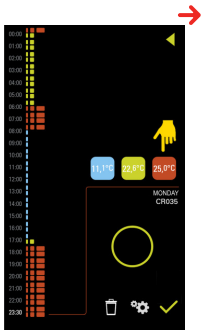

(Fig.12)

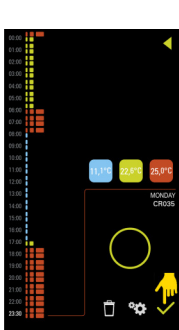

(Fig.13)

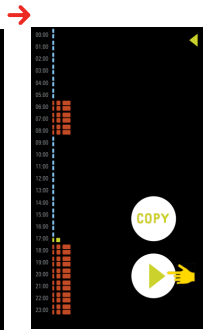

(Fig.14)

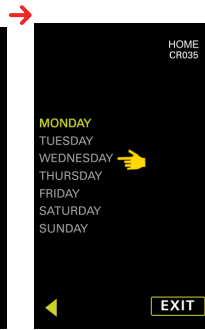

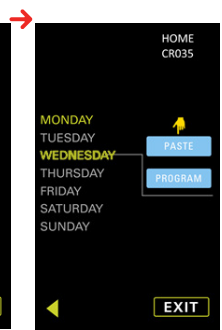

(Fig.15)



(Fig.16)

You can watch the configuration on our TecnoSwitch IT  YouTube channel.

## 5.0 DELETE PROGRAM

Enter the program to be deleted, press  (Fig.17) and confirm with  (Fig.18)

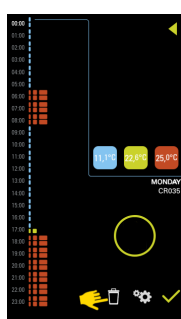

(Fig.17)



(Fig.18)

## 6.0 LANGUAGE SETTING

Follow  to set language.  
(Fig.19 from 19A to 19C)

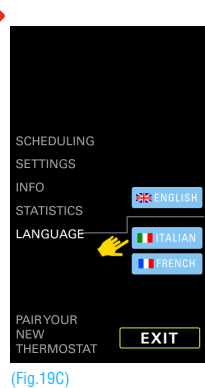
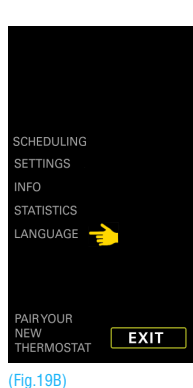
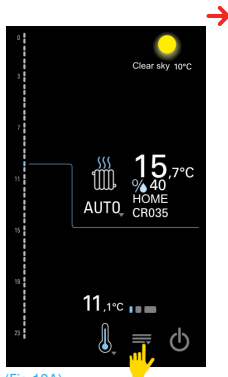

## 7.0 MULTIPLE ASSOCIATIONS

It is possible to manage multiple devices simultaneously, maximum 4, in multiple different places, maximum 2.

We recommend having the device installed by a qualified person.

For more detailed information, see the device installer manual on the [tecnoswitch.com](http://tecnoswitch.com) website.

Tecno Switch reserves the right to make changes to its products in each moment and without further notice.

Tecno Switch declines all responsibility for damage to things or persons derived from an incorrect or improper use of its products.





**tecnoswitch**

keep control

TECNO SWITCH srl  
Via P. Leone Dehon, 99/105 · 76123 Andria (BT) ITALY  
tel (+39) 0883 555323 · fax (+39) 0883 555323  
[tecnoswitch.com](http://tecnoswitch.com)

REV.37-20