

tecnoswitch 

CR035BI

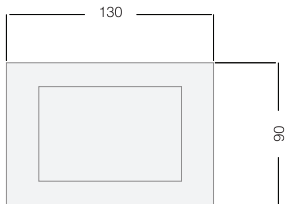

WALL MOUNTED WEEKLY TOUCH PROGRAMMABLE THERMOSTAT



**tecnoswitch** 

## WALL MOUNTED WEEKLY TOUCH PROGRAMMABLE THERMOSTAT

Congratulations for purchasing the CR035BI.

To get the maximum performance, please to read carefully all the instructions.

The programmable thermostat guarantees the best comfort temperature, thanks to easy programming and intuitive graphics interface.

It's supplied with an in-cell touch display with back-lighting that it is the most advanced of the wall-mounted category.

The touch display makes it intuitive, easy to program and unique.

The strengths are:

- Ease of use;
- The high quality of Made in Italy
- Design with attention to the smallest details;
- Super-capacitor technology to keep data in memory.

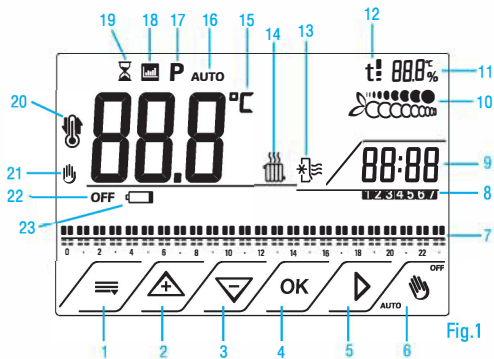

















Fig.1

# COMMANDS AND INDICATIONS

## KEYS LEGEND Fig.1

1.  Menu
2.  Increase
3.  Decrease
4. **OK** Confirm
5.  Scroll to the next icon
6.  ON/OFF - Manual/Automatic

## DISPLAY LEGEND Fig.1

7.  Temperature levels T1, T2, T3
8.  Day of week indicator (1 - 7)
9.  Current time (Clock)
10.  Energy consumption / savings indicator
11.  Set temperature
12.  Set temperature thresholds
13.  Cooling
14.  Heating
15.  Temperature
16. **AUTO** Automatic mode
17. **P** Set temperature levels
18.  Statistics
19.  COUNT-DOWN

20.  Frost protection

21.  Manual Mode

22. OFF :OFF

23.  Low batteries. When the icon appears batteries must be replaced within 15 days.

Note: when the programmable thermostat is in Stand by, press  to start the backlight. Now it can be set.

## INDEX

	page
1. Installation	6
2. Factory setting	9
3. Set day and time	11
4. Set Heating / cooling	14
5. Operating modes	17
6. Daily programming of temperatures	24
7. Set temperature levels T1 T2 T3 heating operation	29
8. Set temperature levels T1 T2 T3 cooling operation	32
9. Lock setting	32
10. Temperature setting	34
11. External probe setting	43
12. Operation with telephone dialer	49
13. Statistics	51
14. Reset	55
15. Supply battery replacement	56
16. Technical features	57

## 1.0 INSTALLATION

The appliance must be installed on a wall at a height of 1,5m off the floor in a suitable position for correctly detecting the ambient temperature. It must not be installed in niches, behind doors and curtains or in areas affected by sources of heat or atmospheric factors. It must be installed on a wall or on 2 and 3 module back boxes, in dry places.

To install the programmable thermostat it is necessary:

- Unhook the base from the thermostat. [Fig.1A](#) and [Fig.2A](#)
- Fix the base to the wall. [Fig.3A](#)
- Connect the load to the terminals following the wiring diagram. [Fig.1B](#) or [Fig.2B](#)
- Connect the external temperature probe and the optional telephone dialer. [Fig.3A](#)
- Fit 1.5 batteries Alkaline AA in the compartment, respecting the batteries polarity. [Fig.4A](#)
- Hook the base to the wall. [Fig.5A](#)

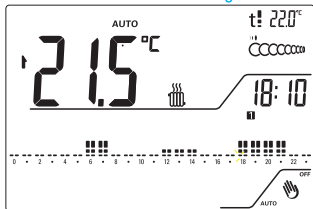

Fig.2

# WIRING DIAGRAM

Fig.1B

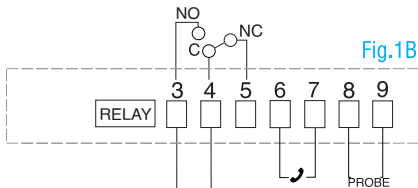
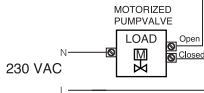
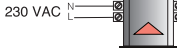
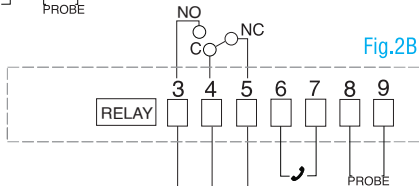

Fig.2B



## ASSEMBLY

Fig.1A



Fig.2A

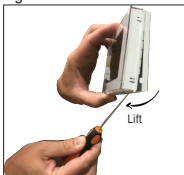

Fig.3A

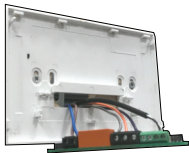
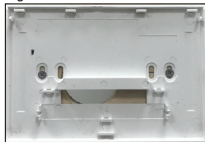

Fig.4A

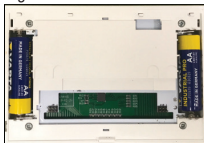
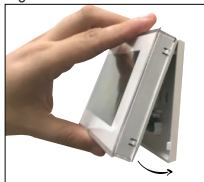

Fig.5A



## 2.0 FACTORY SETTING

For faster use, the programmable thermostat is supplied with the following setting:

- Heating program from Monday to Friday [fig.5](#) and from Saturday and Sunday [fig.6](#).

t. (T1) = 14°C

t: (T2) = 18°C

t! (T3) = 22°C

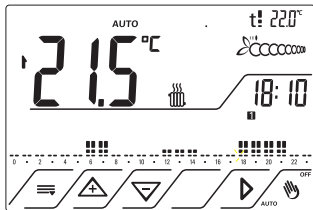

Fig.5

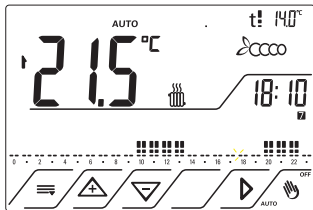

Fig.6

- Cooling Program from Monday to Friday [fig.7](#) and from Saturday and Sunday [fig.8](#).

Temperature levels:

t. (T1) = 24°C

t: (T2) = 26°C

t! (T3) = 28°C



Fig.7

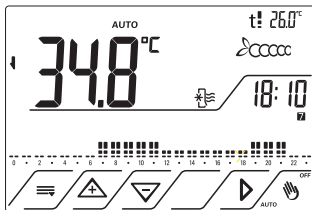

Fig.8

- Frost protection function: +5° C settable, active only in heating mode.
- Set temperature for MANUAL mode. + 22° C.

### 3.0 SET DAY AND TIME

3.1 Starting from Stand-by, [fig.2](#), press  <sup>OFF</sup>. [Fig.9](#)

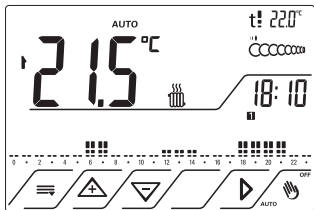

Fig.9

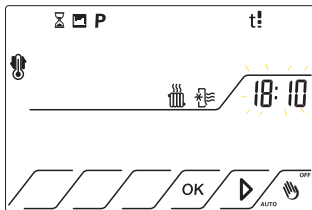
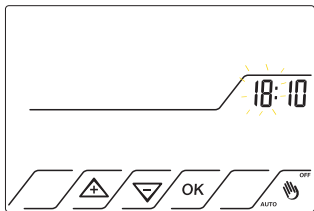



Fig.10

3.2 Press  the clock flashes. [Fig.10](#)



3.3 Press OK to confirm. The hours value flashes. [Fig.11](#)



[Fig.11](#)

3.4 Press  or  to set the current time.

3.5 Press OK to confirm. The minutes value flashes.

3.6 Press  or  to set the minutes value.

3.7 Press OK to confirm. The day value  (Monday) flashes. [Fig.12](#)

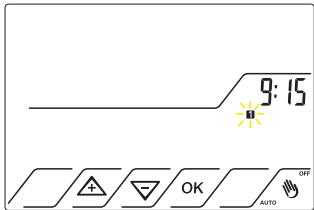



Fig.12

- 3.8 Press  or  and select the desired day **1** that will start to flash.
- 3.9 Press OK to confirm the day.

## 4.0 SET HEATING / COOLING

The programmable thermostat can regulate system of:



4.1 HEATING

4.2 COOLING

### 4.1 SET HEATING

4.1.1 Start the display by pressing  OFF

4.1.2 Press 

4.1.3 Press  up to position on  that it will start to flash and OFF appears. [Fig.13](#)

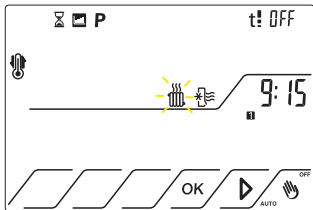



Fig.13

4.1.4 Press OK to confirm. The display shows ON and . If it's not confirmed after 10 seconds it returns to Stand-by.

## 4.2 SET COOLING

4.2.1 Start display by pressing . Fig.9

4.2.2 Press .

4.2.3 Press  up to position on  that will start to flash and OFF appears. Fig.14

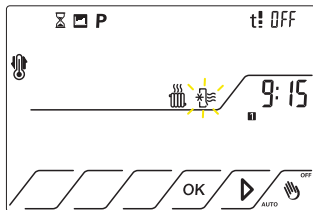

Fig.14

4.2.4 Press OK to confirm. The display shows ON and  fig.15. If it's not confirmed after 10 seconds it returns to Stand-by.

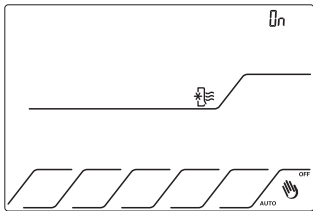

Fig.15

## SYSTEM ACTIVATION SIGNALING

When the icon  or  is animated, the system is active.

## 5.0 OPERATING MODES

The programmable thermostat CR035BI can operate in mode:

5.1 MANUAL

5.2 AUTOMATIC

5.3 COUNT-DOWN

5.4 OFF

### 5.1 OPERATION MANUAL MODE

This function allows you to always have the same temperature.

5.1.1 To set it, start the display by pressing  OFF

5.1.2 Press again 

The display shows  AUTO [Fig.16](#)

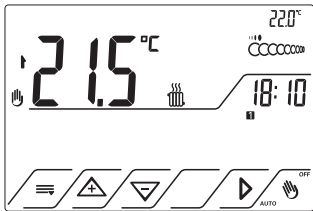



Fig.16

5.1.3 Press  or  to set the desired temperature within a range from +2 and +35°C with steps from 0,1°C.

N.B. : To go back to the Automatic program, press again .

## 5.2 OPERATION AUTOMATIC MODE

The programmable Thermostat regulates the system on / off (heating or cooling) based on the set temperature thresholds, for the sundry days of the week.

From manual mode, start the display by pressing .

Press again . The display shows AUTO. [Fig.17](#)

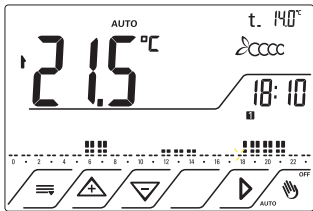



Fig.17

During automatic mode, temperature levels can be displayed by pressing  or .

This action will not change the set program.

When the system is active, the icon  is animated.

To set the program you can see the chapter 6.

### 5.3 OPERATION COUNT-DOWN MODE

If you need to leave home for a few hours or days and so to turn-off the system for a specified time, you can activate the count down mode timed switch-off.

Instead if you wanted to keep a certain temperature for a few hours or days, you can activate the timed switch-on.

The difference between timed switch-off and timed switch-on is determined by the set temperature.

(Ex.: +5°C to TIMED SWITCH-OFF and +25°C to TIMED SWITCH-ON).

When this function is active, no setting can be made.

The OPERATION COUNT-DOWN MODE has two settings:

- TIMED SWITCH-OFF

- TIMED SWITCH-ON

TIMED SWITCH-OFF

This function serves to switch off the system for a lapse of time.

5.3.1 Start display by pressing  .

5.3.2 Press  .

5.3.3 Press  up to position on  that it will start to flash and OFF appears. [Fig.18](#)

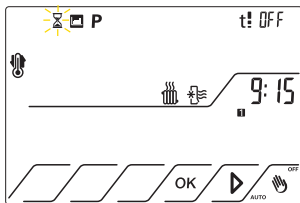

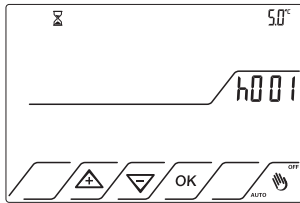

[Fig.18](#)



[Fig.19](#)

5.3.4 Press OK to confirm. The hour counter h0 01 flashes. [Fig.19](#)

5.3.5 Press  or  to set number of hours (e.g. if you want to switch off the thermostat for a week, you have, you have to set  $7 \times 24 = 168$  hours).

5.3.6 Press OK to confirm. Now the set temperature  $+5^{\circ}\text{C}$  flashes. If the ambient temperature exceeds this value, the programmable thermostat will be off.

5.3.7 Press OK to confirm the set temperature.



5.3.8 Press for 4 seconds  to start the COUNT-DOWN.

5.3.9 Press for 4 seconds  to deactivate COUNT-DOWN.

## TIMED SWITCH-ON

This function may be used to maintain a temperature value for a period of time set by the user.

5.3.10 Repeat steps from 5.3.1 to 5.3.6. The set temperature flashes.

5.3.11 Press  or  to set a higher temperature than ambient temperature (ex.. $25^{\circ}\text{C}$ ) and press OK to confirm.

So the programmable thermostat will switch on the load as it will detect a lower temperature.

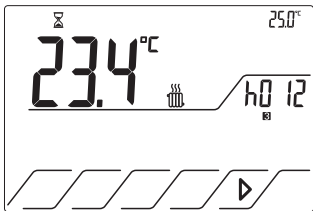

Fig.20A

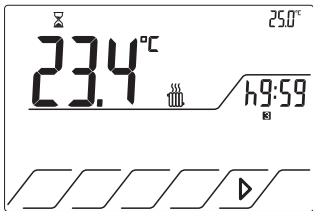

Fig.20B

During the COUNT-DOWN, when less than 10 hours remain, the display shows both the remaining hours and the minutes (e.g. 12 hours: display shows h0:12. Fig.20A  
9 hours and 59 minutes: display show h9:59)Fig.20B .

5.3.12 To activate/deactivate the COUNT-DOWN, follow the steps 5.3.8 e 5.3.9  
At this point the count-down program start. (E.g 12 hours timed switch-on).Fig.20

#### 5.4 FUNCTION OFF



5.4.1 Press for 4  seconds to switch-of programmable thermostat. Now the FUNCTION OFF is activated. It can be activated with or without Frost Protection. It is important to avoid damage caused by low temperatures Fig.21 shows that the system is OFF with Frost Protection function active.

Fig.22 shows that the system is OFF with Frost Protection function disabled, shown the symbol  . To set it follow the chapter 10.4

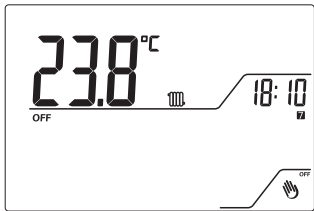

Fig.21

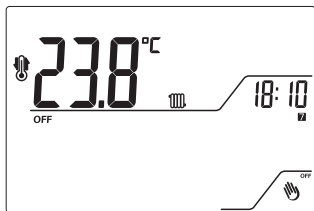

Fig.22

5.4.2 Press for 4 seconds  to switch-on the programmable thermostat. The display shows On for 3 seconds. [Fig.23](#)

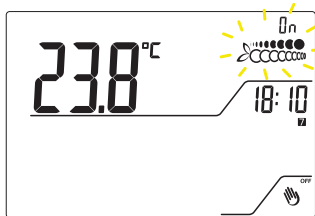

Fig.23

## 6.0 DAILY PROGRAMMING OF TEMPERATURES

The programmable thermostat is supplied with the following temperature level settings:

E.g. Monday/Friday

from 00.00 to 05.59: T1

from 06.00 to 07.59: T3

from 08.00 to 11.59: T1

from 12.00 to 14.59: T2

from 15.00 to 17.59: T1

from 18.00 to 21.59: T3

from 22.00 to 23.59: T1 [Fig.24](#)

It can customize the temperature levels of the Automatic operation, at 30 minute intervals.

Proceed as follows:

6.1 Press  <sup>OFF</sup>

6.2 Press  <sup>AUTO</sup>

6.3 Press  to position on **P** that it will start to flash.

6.4 Press OK to confirm. The day value  flashes as [fig.24](#).

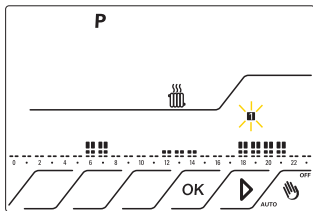

Fig.24

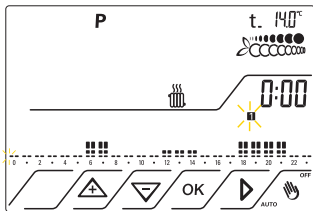

Fig.25

6.5 Press OK to set the Monday  program [fig.25](#).

the display shows:

The icon  flashes. [Fig.25](#)

The clock shows the time 0:00 relative to the flashing segment [Fig.25](#).

The set temperature level (T1 14°) is displayed in reference to the half hour indicated by the flashing segment.

6.6 Press  or  to set the desired temperature range at the time.

6.7 Press  to move on the next half hour and choose the desired temperature range.

Continue in the same way until you reach 11:30 pm. Now, Monday is set. [Fig.26](#)

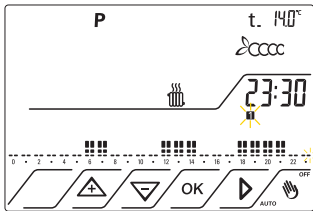

Fig.26

6.8 Press OK to confirm

NOTE: If you are at 18:00 and touch OK, you confirm and the Monday setting ends.

The days 1 and 2 flash alternately.

Now you can:

a) - copy the program. [Fig.27](#)

b) - set the program. [Fig.27](#)

a) 6.9 Copy the program from Monday **1** to Tuesday **2** pressing OK.

b) 6.10 set the Tuesday program **2** pressing **▶** and then press OK to confirm.

6.10.1 repeat the steps 6.6 - 6.7 to copy/set the other days.

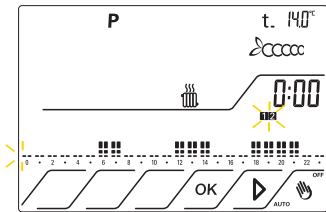

[Fig.27](#)

6.11 Continue up to **7** (Sunday)

N.B.: Factory setting for Saturday **6** and Sunday **7** is different from the other days

## 7.0 SET TEMPERATURE LEVELS T1 T2 T3 FOR HEATING OPERATION

The programmable thermostat is supplied with these set temperature values:

t. (T1) = 14°C

t: (T2) = 18°C

t! (T3) = 22°C

Make sure that the symbol  for Heating is active, otherwise see chapter 4.

7.1 Press  .

7.2 Press  .

7.3 Press  up to position on t that it will start to flash

7.4 Press OK to confirm. The display shows the first level value T1 14° C. [Fig.28](#)

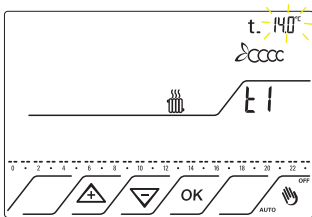

Fig. 28

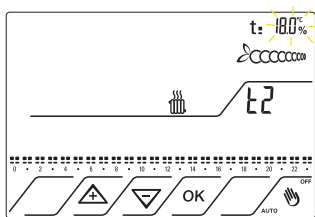

Fig. 29

7.5 Press or to set the desired value.

7.6 Press OK to confirm the temperature.

7.7 Then the display shows the second level value: T2. The relative set temperature 18°C flashes. [Fig.29](#)

7.8 Press or to set the desired value.

7.9 Press OK to confirm the temperature.

7.10 Then the display shows the third level value T3. The relative set temperature 22°C flashes. Fig.30

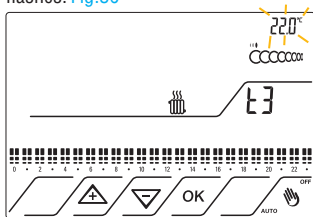

Fig.30

7.11 Press  $\Delta$  or  $\nabla$  to set the desired value.

7.12 Press OK to confirm the temperature.

Note. The temperature  $t_3$  (T3) cannot be  $\leq t_2$  (T2) or  $> + 35^\circ\text{C}$ . The temperature  $t_2$  (T2) cannot be  $\leq t_1$  (T1). While  $t_1$  (T1) can not be  $< + 2^\circ\text{C}$ .

## 8.0 SET TEMPERATURE LEVELS T1 T2 T3 FOR COOLING OPERATION

The programmable thermostat is supplied with the following set temperature values:

t. (T1) = 24°C

t: (T2) = 26°C

t! (T3) = 28°C

Make sure that the symbol  for cooling is active, otherwise see chapter 4.2.



8.1 To Set the desired temperature value in the 3 levels, repeat the chapter 7.

## 9.0 LOCK SETTING

The programmable thermostat is provided with a 3 digit Lock Code.

To activate the function:

9.1 Press  <sup>OFF</sup>  
AUTO

9.2 Press and hold simultaneously for 4 seconds  and  and PAS appears.

9.3 After 3 seconds, the first digit on the left will flash, so press  or  to set it. [Fig.31](#)

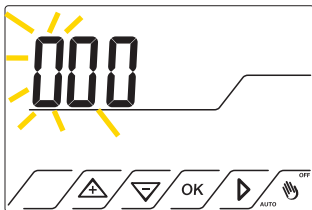

[Fig.31](#)

9.4 Press  to move to the other two digits.

9.5 Press  or  to set the other two digits.

9.6 Press OK to confirm the Password.

9.7 Pressing any key PAS appears. To deactivate it, repeat the steps 9.1 - 9.6

Note: If you have forgotten your password, you can delete it by resetting the programmable thermostat. See chapter 15. Reset.

## 10.0 TEMPERATURE SETTING

Moving on icon  , you can set these function:

- 10.1 - TEMPERATURE DIFFERENTIAL;
- 10.2 - TEMPERATURE IN A PROPORTIONAL WAY;
- 10.3 - CORRECTION OF MEASURED TEMPERATURE;
- 10.4 - FROST PROTECTION;
- 10.5 - ANTI-SEIZE PUMP.

The programmable thermostat is supplied with ON-OFF Temperature Regulation with a Thermal Differential set at  $0.3^{\circ}\text{C}$ .

### 10.1 TEMPERATURE DIFFERENTIAL

It works ON/OFF. Once a temperature value has been set, the temperature differential is the difference between this value and the system switch-on or switch-off temperature. For example, having set a temperature of  $20^{\circ}\text{C}$  and differential of  $0.3^{\circ}\text{C}$ , the system switches on when the temperature reaches  $19.7^{\circ}\text{C}$  and turns off when it reaches  $20.3^{\circ}\text{C}$ .

By choosing the different based on the type of system, continuous switching on and off is avoided. Therefore we recommend a low thermal differential for system with high thermal inertia (system with cast iron radiators or underfloor heating) and the high one for low inertia systems (eg ventilators, fan coils, etc. ..).

To set temperature differential:

10.1.1 Press  .

10.1.2 Press  .

10.1.3 Press  up to position on  that it will start to flash. [Fig 32](#)

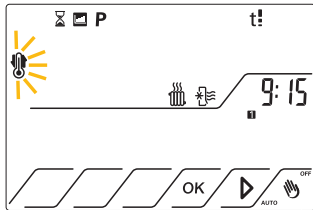

Fig.32

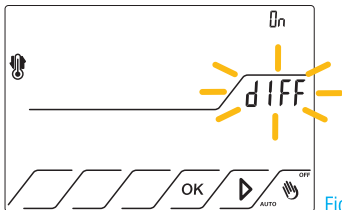

Fig.33

10.1.4 Press OK to confirm. **dIFF** appears and flashes. ON state appear and indicates that the differential regulation is active. [Fig.33](#)

10.1.5 Press OK

10.1.6 Press  $\triangle$  or  $\nabla$  to set the desired differential value between 0.1 and 1° C.

10.1.7 Press OK to confirm. [Fig.32](#)

## 10.2 TEMPERATURE IN A PROPORTIONAL WAY

It makes the temperature inside the building more stable.

To set it, you have to:

10.2.1 Repeat the steps 10.1.1 - 10.1.4. [Fig.33](#)

10.2.2 Press  $\blacktriangleright$  and **ProP** appears and flashes. The status is OFF. [Fig.34](#)

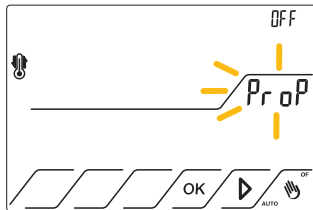

[Fig.34](#)

10.2.3 Press OK to confirm. **bnd** appears and flashes (Breadth of adjustment range). This value can be adjusted from 0.5° C to 7° C with a resolution of 0.1° C. The factory setting is 1° C.

10.2.4 Press  or  to set the desired Breadth value. [Fig.35](#)



10.2.5 Press OK to confirm. The **tc** appears and flashes (System Cycle Time). It can choose between 5 values: 5, 10, 20, 30, 40 minutes. The factory setting is 20 minutes. [Fig.36](#)

Example. Set the temperature 19.5° C with Breadth of adjustment range 1° C.  
If the ambient temperature is lower than 18.5° C the heating 100% on; as the ambient temperature approaches the set temperature, the system power decreases.  
Note: For location with good thermal insulation it is advisable to set small band values.



Fig.36

10.2.6 Press  $\triangle$  or  $\nabla$  to set the desired tc value.

10.2.7 Press OK to confirm.

TC stand the time in wich a cycle of regulation is completed. The solicitation of the plant is greater as less tc is. Note. High Inertial plants like boiler requires long cycle time like 20, 30, 40, minutes.

By setting the proportional temperature control, the one with differential is deactivated and vice versa.

### 10.3 CORRECTION OF MEASURED TEMPERATURE

If the programmable thermostat is installed close to sources of heat (like heaters, radiators, air conditioners) the measured (current) temperature may not be correct the measured (current) temperature by screen from 0° C (factory setting) to +/- 3°C.

To set it.

10.3.1 Repeat the steps 10.1.1 - 10.1.4. [Fig.33](#)

10.3.2 Press **▶** up to position on **corr** that it will start to flash.

10.3.3 Press OK to confirm start to flash the value 0.0° C. [Fig.37](#)

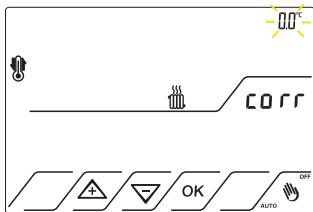

[Fig.37](#)

10.3.4 Press  or  to set the desired correction value between -3 and + 3° C.

10.3.5 Press OK to confirm.

## 10.4 FROST PROTECTION FUNCTION

It's important to avoid damage caused by too low temperatures. This function works only in the Heating mode. The default temperature is + 5° C. If the temperature drops below this value the system starts working.

Set the desired temperature within a range from 2° C to 7° C.

10.4.1 Repeat the steps 10.1.1 al 10.1.4. [Fig.33](#)

10.4.2 Press  up to position on **Ant** that it will start to flash.

10.4.3 Press OK to confirm. The set temperature flashes.

10.4.4 Press  or  to set the desired frost protection temperature. [Fig.38](#)

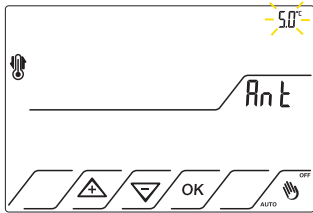



Fig.38

#### 10.4.5 Press OK to confirm

Note. below 2° C the frost protection is OFF. When the programmable thermostat is OFF, the icon  is on the display, so the frost protection don't work.

## 10.5 PUMP ANTI-SEIZE FUNCTION

The device is provided of pump anti-seize function, this allow to start a count-down that switch on the relay per one minute every 24 hours.

This function is only available on HEATING mode and is setting "OFF" by default Fig.39, to activate it:

10.5.1 Repeat the steps 10.1.1 -10.1.4. Fig.33

10.5.2 Press **▶** until "Gr1" is flashing.Fig.39

10.5.3 Press **OK**, **OFF** will flash.

10.5.4 Press **▲** , the function state will change from **OFF** to **ON**.Fig.40

10.5.5 Press **OK** to confirm.

10.5.6 To deactivate the function, repeat the step listed above until 10.5.3, press **▼** , the function state will change from **ON** to **OFF**. Press **OK** to confirm.



Fig.39

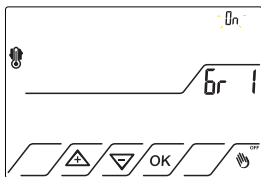

Fig.40

## 11.0 EXTERNAL PROBE SETTING

The programmable Thermostat has an input for 10k External probe (not supplied) that works in the range between - 10° C and 60 ° C.

11.1 - EXTERNAL PROBE ON/OFF

11.2 - ENVIRONMENT PROBE

11.3 - EXTERNAL PROBE

11.4 - UNDERFLOOR PROBE

To set the External Temperature Probe, proceed as follows:

11.1 - EXTERNAL PROBE ON/OFF

11.1.1 Press 

11.1.2 Press  and hold for 3 seconds  and **SO** appears and flashes. **OFF** indicates that the probe disabled.

11.1.3 Press OK to confirm or press  to move on other function 11.2, 1.3 or 11.4.

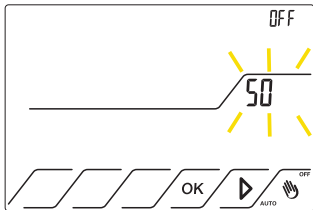

Fig.41

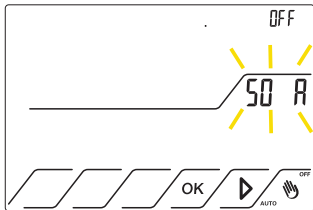



Fig.42

## 11.2 - ENVIRONMENT PROBE

The plants is only regulated by external probe detected temperature.

11.2.1 Repeat the steps 11.1.1 and 11.1.2

11.2.2 Press  up to position on **SO A** that it will start to flash. The status is OFF. [Fig.42](#)

11.2.3 Press OK to confirm. On appears.

From now, the temperature measured by the external probe regulates the system. The display shows the temperature measured by the external probe.

### 11.3 EXTERNAL PROBE

It only measures another temperature, of the external probe. The system settings do not change.

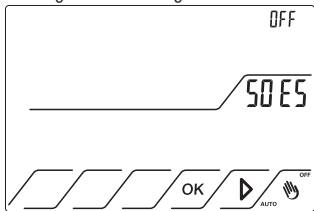





Fig.43

11.3.1 Repeat the steps 11.1.1 e 11.1.2

11.3.2 Press  up to position on **SO ES** that will start to flash. The status is OFF. [Fig 43](#)

11.3.3 Press OK to confirm. On appears. From now will be displayed a second temperature.

To display the external probe temperature, from standby press  then press  and Int, ambient temperature, appears. Press again  and Est, temperature measured by the probe, appears.

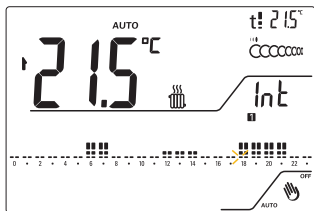

Fig.44a

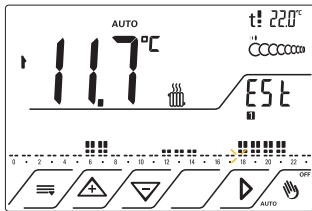



Fig.44b

## 11.4 UNDERFLOOR PROBE

If the temperature value measured by the underfloor probe exceeds the set temperature, the system is switched off.

The temperature regulation is managed by the internal probe.

11.4.2 Press  up to position on **SO PA** that it will start to flash. The status is OFF. [Fig.45](#)

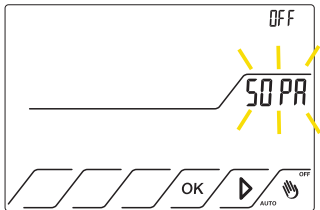

Fig.45

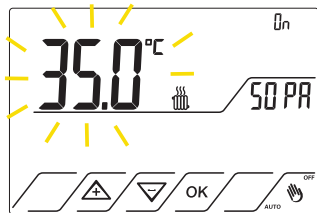

Fig.46

11.4.3 Press OK to confirm. On appears and the limit temperature flash.

11.4.4 Press  $\triangle$  or  $\nabla$  to set the value in the range between +2 and + 60°C. Fig.46  
 Factory setting 35° C.

11.4.5 Press OK to confirm.

From this moment if the value detected by the floor probe exceeds the set limit temperature, the system is switched off. Over temperature protection function. Temperature control is managed by the internal thermostat probe.

Note. If one of the function is active, all the others will be deactivated automatically.





## 12.0 OPERATION WITH TELEPHONE DIALER

By connecting a telephone programmer to the terminals with the phone symbol [fig.1B e 2B](#) it is possible to remotely activate a special program called Timed Manual.

The programmable thermostat has 2 different programs in memory, one for Heating and one for Cooling.

To activate it, just give it a pulse of about half second.

To deactivate the activated program, just give an impulse again, or press  to start the display and press and hold for about 4 seconds .

The display shows: "r", , set temperature and the time remaining until the end of the program.

The default programs are:

Heating: 1 hour at 22° C;

Cooling : 1 hour at 25° C;

To set the temperature and the number oh hours, proceed as follows:

12.1 Select the operating mode:  or  .

12.2 Press  .



12.3 Press  .

12.4 Press  up to position on  that it will start to flash. OFF appears.

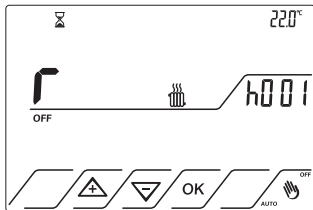
12.5 Press and hold OK for about 3 seconds. The hour counter h0 01 flashes. [Fig.48](#)



[Fig.48](#)

12.6 Press  or  to set the number of the hours.

12.7 Press OK to confirm. The set temperature 22° flashes.

12.8 Press  or  to set the desired value.



12.9 Press OK to confirm.

## 13.0 STATISTICS

The programmable thermostat shows statistical data on the operation of the system.

13.1 Press  .

13.2 Press  .

13.3 Press  up to position on  that will start to flash and press OK to confirm. The number of the first page 01 is shown at the top right. There are 5 of them.

Page 1

**hcd e 1:35** : this means that on the current day the system worked for 1 hour and 35 minutes. [Fig.49](#)



Fig.49



Fig.50

13.4 Press  to move on page 3. [Fig.50](#)

PAGE 2

**hLd e 02:30**: this means that on the day before the system worked for 2 hours and 30 minutes.

13.5 Press  to move on page 3. [Fig.51](#)

PAGE 3

**ht e 03 15**: indicates how many hours the system is working (three hundred fifteen hours)

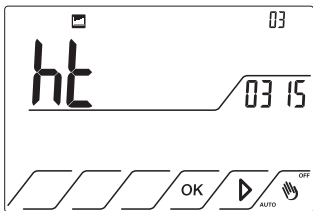

Fig.51

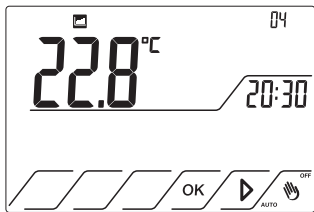

Fig.52

Note. You can reset the hour counter by pressing OK for 3 seconds.

13.6 Press ► to move on page 4. [Fig.52](#)

PAGE 4

**22,8°C e 20:30** : indicate the highest temperature reached and at what time in the day before.

Press  to move on page 5. [Fig.53](#)

PAGE 5

**18,3°C e 03:45**: indicates the lowest temperature reached and at what time in the previous day.

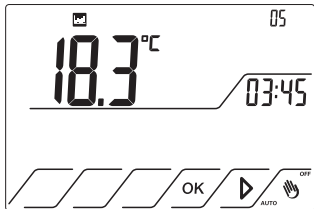

[Fig.53](#)



13.8 Press  to return on the main screen or wait for 15 seconds

## 14.0 RESET

Operating anomalies, interventions or other technical reasons may require the reset of the device and the restore of the factory settings.

It restores the factory settings, also deleting any password.

14.1 From stand by, press  .

14.2 Press and hold simultaneously  and  for 4 seconds. **rSt.** [Fig.54](#)

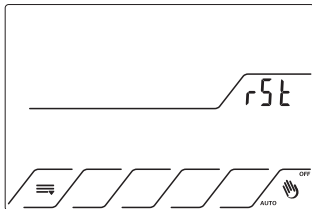

[Fig.54](#)

At this point the device start with all factory settings.

N.B.: in the event of malfunctions even after the standard rest procedure, disconnect the thermostat programmable from the base and reconnect it after 1 minute.

## 15.0 SUPPLY BATTERY REPLACEMENT

When  appears, batteries must be replaced within 15 days. We suggest the replacement of Alkaline AA batteries at the beginning of each season.

Fitting the batteries with the wrong polarity may damage the programmable thermostat.

The correct date and time settings are maintained if the batteries are replaced within 30 seconds thanks to the supercapacitor.

## 16.0 TECHNICAL FEATURES

- Programmable Thermostat with differential and proportional temperature regulation and external probe.
- Temperature Regulation from 2 to 35° C
- Antifreeze temperature from 2 to 7° C
- Correction Temperature from -3 to 3°C
- Breadth of adjustment range from 0,5° C to 7° C of resolution
- System Cycle Time 5, 10, 20, 30, 40 minutes
- Thermal Differential from 0,1 to 1° C
- Functions: Password lock, Anti-seize Pump, Statistics, Count-down, Remote Control
- Maximum external probe distance 10 m
- Protection Degree IP20

## 17.0 SAFETY WARNINGS

During installation and operation of the appliance the following indications must be respected:

- Do not feed the product if it is mechanically damaged.
- Install and start up the appliance in compliance with the current regulations concerning electrical system.
- For malfunctions of the appliance, contact technical assistance.

## 18.0 INFORMATION TO USERS

Pursuant to Legislative Decree No. 49 of March 14, 2014 “ Implementation of Directive 2012/19/EU on waste electrical and electronic equipment (WEEE)”

The “crossed out wheellie bin” WEEE symbol on the appliance show that the product, at the end of its useful life, must be collected separately from other waste. Therefore, the user must provide the equipment with the essential components at the recycling centre for electronic and electrotechnical devices, or return it to the dealer when you purchase an equivalent appliance in one-to-one reason, or 1 to zero for equipment with a side lower than 25cm. The correct recycling helps to avoid possible negative effects on the environment and on health, favoring the recycling of the materials that make up the equipment. The illegal disposal of the product by the user involves administrative sanctions as per Legislative Decree No. 49 of March 14, 2014.

Tecno Switch reserves the right to make changes to its products in each moment and without further notice.

Tecno Switch declines all responsibility for damage to things or persons derived from an incorrect or improper use of its products.



tecnoswitch 







**tecnoswitch**

keep control

TECNO SWITCH srl  
Via P. Leone Dehon, 99/105 · 76123 Andria (BT) ITALY  
tel (+39) 0883 555323 · fax (+39) 0883 555323  
[tecnoswitch.com](http://tecnoswitch.com)

REV. 19-21