

tecnoswitch 

TE035BI

WALL MOUNTED TOUCH THERMOSTAT

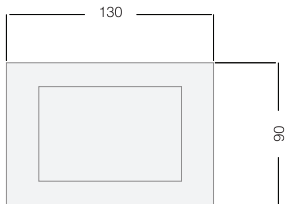



tecnoswitch 

WALL MOUNTED TOUCH THERMOSTAT

Congratulations for purchasing the TE035BI.

To get the maximum performance, please to read carefully all the instructions.

The thermostat guarantees the best comfort temperature, thanks to easy programming and intuitive graphics interface.

It's supplied with an in-cell touch display with back-lighting that it is the most advanced of the wall-mounted category.

The touch display makes it intuitive, easy to program and unique.

The strengths are:

- Ease of use;
- The high quality of Made in Italy
- Design with attention to the smallest details;
- Super-capacitor technology to keep data in memory.

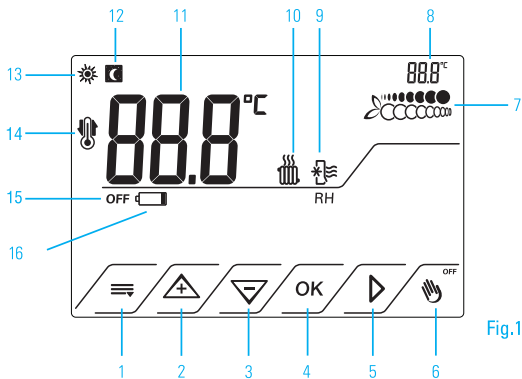















Fig.1

COMMANDS AND INDICATIONS

KEYS LEGEND Fig.1

1.  Menu
2.  Increase
3.  Decrease
4. **OK** Confirm
5.  Scroll to the next icon
6.  ON/OFF - Manual/Automatic

DISPLAY LEGEND Fig.1

7.  Energy consumption / savings indicator
8.  Set temperature
9.  Cooling
10.  Heating
11.  Temperature
12.  Set Reduction temperature ON
13.  Set Comfort temperature ON
14.  Frost protection
15. **OFF** OFF
16.  Low batteries

Note: When the programmable thermostat is in Stand-by, press  to start the backlight. Now it can be set.

INDEX

| | page |
|--|------|
| 1. Installation | 5 |
| 2. Factory setting | 9 |
| 3. Set heating / cooling | 10 |
| 4. Set comfort / reduction temperature | 13 |
| 5. Function Off | 16 |
| 6. Lock setting | 18 |
| 7. Temperature setting | 20 |
| 8. External probe setting | 29 |
| 9. Reset | 36 |
| 10. Supply battery replacement | 37 |
| 11. Technical features | 38 |
| 12. Safety warnings | 39 |

1.0 INSTALLATION

The appliance must be installed on a wall at a height of 1,5m off the floor in a suitable position for correctly detecting the ambient temperature. It must not be installed in niches, behind doors and curtains or in areas affected by sources of heat or atmospheric factors. It must be installed on a wall or on 2 and 3 module back boxes, in dry places.

To install the programmable thermostat it is necessary:

- Unhook the base from the thermostat. [Fig.1A](#) [Fig.2A](#)
- Fix the base to the wall. [Fig.3A](#)
- Connect the load to the terminals following the wiring diagram. [Fig.1B](#) [Fig.2B](#)
- Connect the external temperature probe. [Fig.3A](#)
- Fit. n.2 the batteries Alkaline AA of 1,5 V in the compartment, respecting the batteries polarity. [Fig.4A](#)
- Hook the base to the wall. [Fig.5A](#)

IMPORTANT: Fitting the batteries with the wrong polarity may damage the programmable thermostat. After inserting the batteries correctly, (or after the reset) the device performs a control cycle, turning on all the display segments seconds, [Fig.1](#) and after it goes into stand-by. [Fig.3](#)

Pressing  the other active keys appear. Fig.3

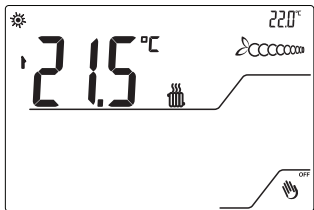

Fig.2

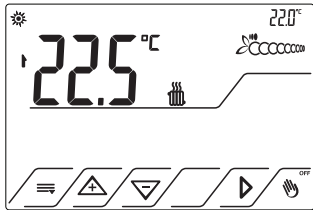
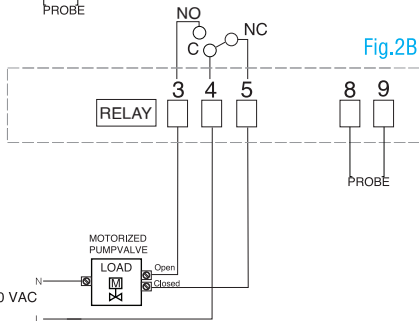
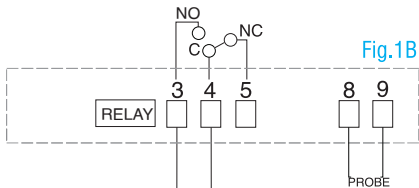

Fig.3

WIRING DIAGRAM



MONTAGGIO

Fig.1A



Fig.2A

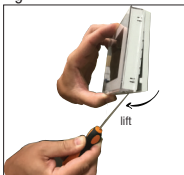

Fig.3A

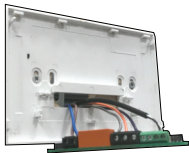
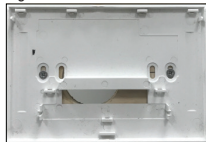

Fig.4A

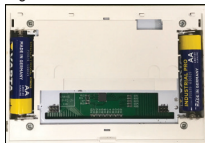





Fig.5A



2.0 FACTORY SETTING

- Heating program:
Reduction temperature  a 14°C
Comfort temperature  a 22°C
- Cooling Program:
Reduction temperature  a 28° C
Comfort temperature  a 24° C
- Frost protection +5°C settable, active only in heating mode

3.0 SET. HEATING / COOLING

The thermostat can regulate system of:



3.1 HEATING

3.2 COOLING

3.1 HEATING

3.1.1 Start the display by pressing . Fig.2

3.1.2 Press . Fig.6

3.1.3 Press  up to position on  that it will start to flash.

3.1.4 Press OK to confirm. The display shows ON and . If it's not confirmed after 10 seconds it returns to Stand-by.

3.2 COOLING

3.2.1 Start display by pressing . Fig.2

3.2.2 Press . Fig.6

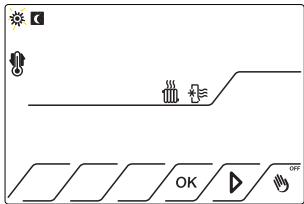



Fig.6

3.2.3 Press ► up to position on  that it will start to flash and OFF appears. [Fig.7](#)

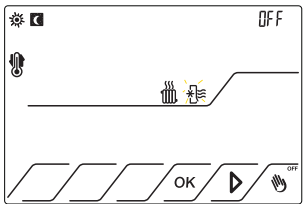



Fig.7

3.2.4 Press OK to confirm. The display shows On and  . If it's not confirmed after 10 seconds it returns to Stand-by.

SYSTEM STATUS

the system status is indicated on the display by the respective icons.
Below are the symbols that describe its operation.

System ON:  / 

System OFF:  / 

4.0 SET COMFORT / REDUCTION TEMPERATURE

You can set the Reduction or Comfort temperature for:

4.1 Heating mode

4.2 Cooling mode

You can set the temperature between +2 and + 35° C in steps of 0.1 ° C by pressing

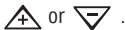

4.1 Heating

Make sure that the icon  is active.

4.1.1 Press  ^{OFF} Fig.2

4.1.2 Press  Fig.6

4.1.3 Press  up to position  /  that it will start to flash. Fig.8

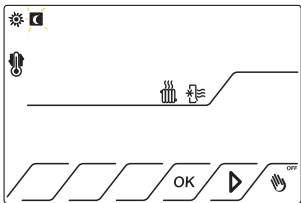

Fig.8

4.1.4 Press OK. Fig.9

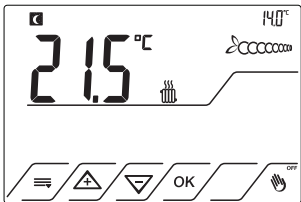







Fig.9

4.1.5 Press  or  to set the desired Reduction  or Comfort value  .
If it's not continued after 10 seconds it returns to Stand-by.

4.1.6 Press OK to det the desired temperature.

4.2 Cooling

Make sure that the symbol  is active.

4.2.1 to set, repeat the steps 4.1.1 a 4.1.6.

5.0 FUNCTION OFF

5.1 Press for 4 seconds  to switch-off thermostat. Now the FUNCTION OFF is activated. It can be activated with or without Frost Protection. It is important to avoid damage caused by low temperatures,

[fig.10](#) shows that the system is OFF with Frost Protection function active.

[fig.11](#) shows that the system is OFF with Frost Protection function disabled, shown from icon . To set it, follow the chapter 10.

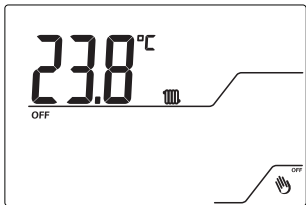

Fig.10

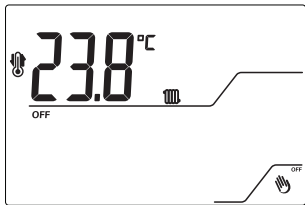
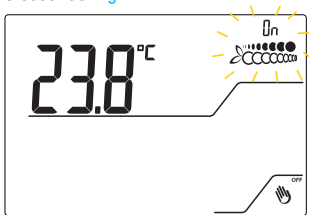

Fig.11

5.2 Press for 4 seconds  to switch-on the thermostat. The display shows ON for 3 seconds. [Fig.12](#)



[Fig.12](#)

6.0 LOCK SETTING

The thermostat is provided with a 3 digit Lock Code.

This function locks the display to avoid accidental changes to the settings caused by unintentionally touching the screen:

6.1 Start display by pressing  ^{OFF}. Fig.2

6.2 Press and hold simultaneously for 4 seconds  and  up to position on **PAS**.

6.3 After 3 seconds, the first digit on the left will flash so press  or  to set it. Fig.13



Fig.13

6.4 Press  to move to the other two digits.

6.5 Press  or  to set the other two digits.

6.6 Press OK to confirm the Password.

Pressing any key **PAS** appears.

Note: If you do not confirm with OK key within 10 seconds, you return to the previous function without having set the password.

6.7 To deactivate it, repeat the steps 6.1 - 6.6.

Note: If you have forgotten your password, you can delete it by resetting the thermostat. See chapter Reset.

7.0 TEMPERATURE SETTING

Moving on icon , you can set these function:

7.1 - TEMPERATURE DIFFERENTIAL;

7.2 - TEMPERATURE IN A PROPORTIONAL WAY;

7.3 - CORRECTION OF MEASURED TEMPERATURE;

7.4 - FROST PROTECTION;

7.5 - ANTI-SEIZE PUMP FUNCTION.

The thermostat is supplied with ON-OFF Temperature Regulation with a Thermal Differential set 0.3 ° C.

7.1 TEMPERATURE DIFFERENTIAL

It works ON/OFF. Once a temperature value has been set, the temperature differential is the difference between this value and the system switch-on or switch-off temperature.

For example, having set a temperature of 20°C and a differential of 0.3°C, the system switches on when the temperature reaches 19.7° C and turns off when it reaches 20.3°C.

By choosing the differential based on the type of system, continuous switching on and off is avoided. Therefore we recommend a low thermal differential for systems with high thermal inertia (systems with cast iron radiators or underfloor heating) and the high one for low inertia systems (eg ventilators, fancoils, etc...).

To set temperature differential:

7.1.1 Press  .

7.1.2 Press  .

7.1.3 Press  up to position on  that it will start to flash. [Fig.14](#)

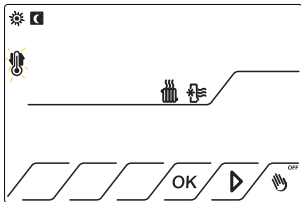

[Fig.14](#)

7.1.4 Press OK to confirm. **dIFF** appears and flashes. ON state appear and flashes. ON state appear and indicates that the differential regulation is active.

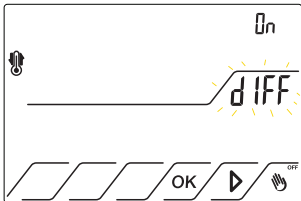

Fig.15

7.1.5 Press OK.

7.1.6 press  or  to set the desired differential value between 0.1 and 1°C.

7.1.7 Press OK to confirm. Fig.15

7.2 TEMPERATURE IN A PROPORTIONAL WAY

It makes the temperature inside the building more stable.

To set it, you have to:

7.2.1 Repeat the steps 7.1.1-7.1.4. [Fig.15](#)

7.2.2 Press  and **ProP** appears and flashes. The status is OFF. [Fig.16](#)

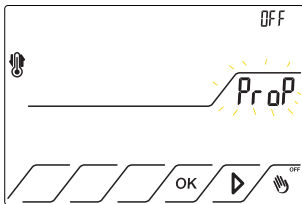

[Fig.16](#)

7.2.3 Press OK to confirm. **bnd** appears and flashes (Breadth of adjustment range). This value can be adjusted from 0.5°C to 7°C with a resolution of 0.1°C. The factory settings is 1°C. [Fig.17](#)



Fig.17

7.2.4 Press \triangle or ∇ to set the desired Breadth value.

7.2.5 Press OK to confirm. tc appears and flashes (System Cycle Time).

It can choose between values: 5, 10, 20, 30, 40 minutes. The factory setting is 20 minutes. Fig.18

Example: Set Temperature 19.5°C with Breadth of adjustment range 1°C.

If the ambient temperature is lower than 18.5° C the heating is 100% on; as the ambient temperature approaches the set temperature, the system power decreases.

Note: For location with good thermal insulation it is advisable to set small band values.



Fig.18

7.2.6 Press \triangleup or ∇ to set desired tc value.

7.2.7 Press OK to confirm.

tc stand for the time in which a cycle of regulation is completed. The solicitation of the plant is greater as less tc is.

Note: High inertial plants like a boiler requires long cycle time like 20, 30, 40 minutes. By setting the proportional temperature control, the one with differential is deactivated and vice versa.

7.3 CORRECTION OF MEASURED TEMPERATURE

If the programmable thermostat is installed close to sources of heat (like heaters, radiators, air conditioners) the measured (current) temperature may not be correct. For this reason it can correct the measured (current) temperature by screen from 0 °C (factory setting) to $\pm 3^{\circ}\text{C}$:

7.3.1 Repeat the steps 7.1.1 - 7.1.4

7.3.2 Press  up to position on **corr** that it will start to flash.

7.3.3 Press OK to confirm. The set value of 0.0° C flashes. [Fig.19](#)

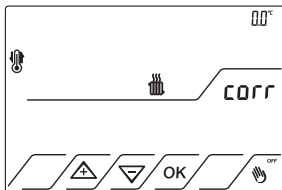

[Fig.19](#)

7.3.4 Press  or  to set the desired correction value between -3 and +3°C.

7.3.5 Press OK to confirm.

7.4 FROST PROTECTION FUNCTION

It's important to avoid damage caused by too low temperatures. This function works only in the Heating mode. The default temperature is +5°C. If the temperature drops below this value the system starts working.

Set the desired temperature within a range from 2°C to 7°C:

7.4.1 Repeat the steps 7.1.1 - 7.1.4

7.4.2 Press  up to position on **Ant**, it will start to flash.

7.4.3 Press OK to confirm.

7.4.4 Press  or  to set the desired frost protection. [Fig.20](#)

7.4.5 Press OK to confirm.

Note: below 2° C the frost protection is OFF. When programmable thermostat is OFF, the icon  is on the display, so the frost protection don't work.



[Fig.20](#)

7.5 PUMP ANTI-SEIZE FUNCTION

The device is provided of pump anti-seize function, this allow to start a count-down that switch on the relay per one minute every 24 hours.

This function is only available on HEATING mode and is setting “OFF” by default [Fig.21](#), to activate it:

7.5.1 Repeat the steps 7.1.1 -7.1.4. [Fig.15](#)

7.5.2 Press **▶** until "Gr1" is flashing. [Fig.21](#)

7.5.3 Press **OK**, **OFF** will flash.

7.5.4 Press **▲**, the function state will change from **OFF** to **ON**. [Fig.22](#)

7.5.5 Press **OK** to confirm.

7.5.6 To deactivate the function, repeat the step listed above until 7.5.3, press **▼**, the function state will change from **ON** to **OFF**. Press **OK** to confirm.

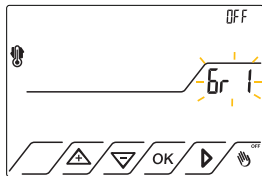

[Fig.21](#)

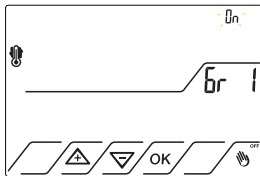

[Fig.22](#)

8.0 EXTERNAL PROBE SETTING

The thermostat has an input for 10k External probe (not supplied) that works in the range between -10°C and 60°C.

the probe is used in these modes:

8.1 - EXTERNAL PROBE ON/OFF

8.2 - ENVIRONMENT PROBE

8.3 - EXTERNAL PROBE

8.4 - UNDERFLOOR PROBE

To set the External Temperature Probe, proceed as follows:

8.1 EXTERNAL PROBE ON/OFF

8.1.1 Press 

8.1.2 Press and hold for 3 seconds  and **SO** appears and flashes. OFF indicates that the probe is disabled.

8.1.3 Press OK to confirm or press  to move on other function 8.2, 8.3, or 8.4.

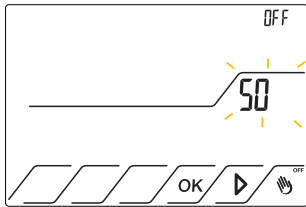

Fig.23



Fig.24

8.2 ENVIRONMENT PROBE

The plants is only regulated by external probe detected temperature.

8.2.1 Repeat the steps 8.1.1 e 8.1.2

8.2.2 Press  up to position on **SO A** that it will start to flash. The status is OFF.

8.2.3 Press OK to confirm. On appears. From now, the temperature measures by external probe regulates the system. The display shows the temperature measured by the external probe.

8.3 EXTERNAL PROBE



It only measures another temperature, of the external probe. The system settings do not change.

8.3.1 Repeat the steps 8.1.1 e 8.1.2

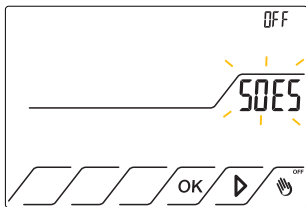
8.3.2 Press  up to position on **SO ES** that it will start to flash. The status is OFF. [Fig.25](#)



[Fig.25](#)

8.3.3 Press OK to confirm. On appears. From now will be displayed a second temperature.
8.3.4 To display the external probe temperature, from standby press  then press  and **Int**, ambient temperature appears. Press again  and **Est** appears, temperature measures by the probe. [Fig.26](#)

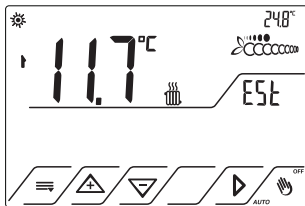
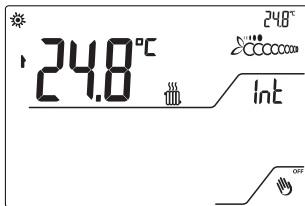

[Fig.26](#)

8.4 UNDERFLOOR PROBE

If the temperature value measured by the underfloor probe exceeds the set temperature, the system is switched off.

The temperature regulation is managed by the internal probe.

8.4.1 Repeat the steps 8.1.1 e 8.1.2

8.4.2 Press  up to position on **SO PA** that it will start to flash. The status is OFF. [Fig.27](#)

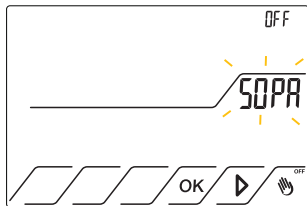

[Fig.27](#)

8.4.3 Press OK to confirm. On appears. The limit temperature flash.

8.4. Press  or  to set the value in the range between + 2 and + 60°C

Factory setting 35°C. [Fig.28](#)

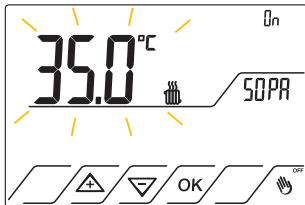

Fig.28

8.4.5 Press OK to confirm.

From now if the value detected by the floor probe exceeds the set limit temperature, the system is switched off. Overtemperature protection function. The thermoregulation is managed by the internal thermostat probe.

Note. If one of the function is active, all the others will be deactivated automatically.

9.0 RESET

Operating anomalies, interventions or other technical reasons may require the reset of the device and the restore of the factory settings.

It restores the factory settings, also deleting any password.

9.1 From stand-by, press 

9.2 Press and hold simultaneously  and  for 4 seconds. **rSt** appears. [Fig.30](#)

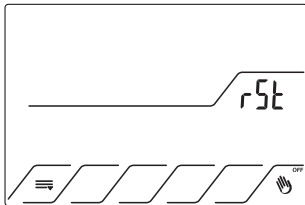

[Fig.30](#)

At this point the device start with all factory settings.

NB: In the event of malfunctions that cannot be resolved with the standard reset procedure, disconnect the thermostat from the base and reconnect it after 1 minute.

10.0 SUPPLY BATTERY REPLECEMENT

When  appears, batteries must be replaced within 15 days. We suggest the replacement of Alkaline AA batteries at the beginning of each season.

Fitting the batteries with the wrong polarity may damage the programmable thermostat.

The correct date and time settings are maintained if the batteries are removed and replaced within 30 seconds thanks to the supercapacitor.

11.0 TECHNICAL FEATURES

- Thermostat with differential and proportional temperature regulation and external probe.
- Temperature Regulation from 2 to 35° C
- Antifreeze temperature from 2 to 7° C
- Correction Temperature from -3 to 3°C
- Breadth of adjustment range from 0,5° C to 7° C of resolution
- System Cycle Time 5, 10, 20, 30, 40 minutes
- Thermal Differential from 0,1 to 1° C
- Functions: Password lock, Anti-seize Pump.
 - Maximum external probe distance 10 m
- Protection Degree IP20
- Microdisconnection 1BU
- Relay output with clean change- over contacts NO/COM e NC 6A 250 Vac
- Software Class A
- Backlighted LCD display
- Supercapacitor technology

12.0 SAFETY WARNINGS

During installation and operation of the appliance the following indications must be respected:

- Do not feed the product if it is mechanically damaged.
- Install and start up the appliance in compliance with the current regulations concerning electrical system.
- For malfunctions of the appliance, contact technical assistance.

INFORMATION TO USERS

Pursuant to Legislative Decree No. 49 of March 14, 2014 “ Implementation of Directive 2012/19/EU on waste electrical and electronic equipment (WEEE)”

The “crossed out wheellie bin” WEEE symbol on the appliance show that the product, at the end of its useful life, must be collected separately from other waste. Therefore, the user must provide the equipment with the essential components at the recycling centre for electronic and electrotechnical devices, or return it to the dealer when you purchase an equivalent appliance in one-to-one reason, or 1 to zero for equipment with a side lower than 25cm. The correct recycling helps to avoid possible negative effects on the environment and on health, favoring the recycling of the materials that make up the equipment. The illegal disposal of the product by the user involves administrative sanctions as per Legislative Decree No. 49 of March 14, 2014.

Tecno Switch reserves the right to make changes to its products in each moment and without further notice.

Tecno Switch declines all responsibility for damage to things or persons derived from an incorrect or improper use of its products.



tecnoswitch 





tecnoswitch
keep control

TECNO SWITCH srl
Via P. Leone Dehon, 99/105 · 76123 Andria (BT) ITALY
tel (+39) 0883 555323 · fax (+39) 0883 555323
tecnoswitch.com

REV.22-21